

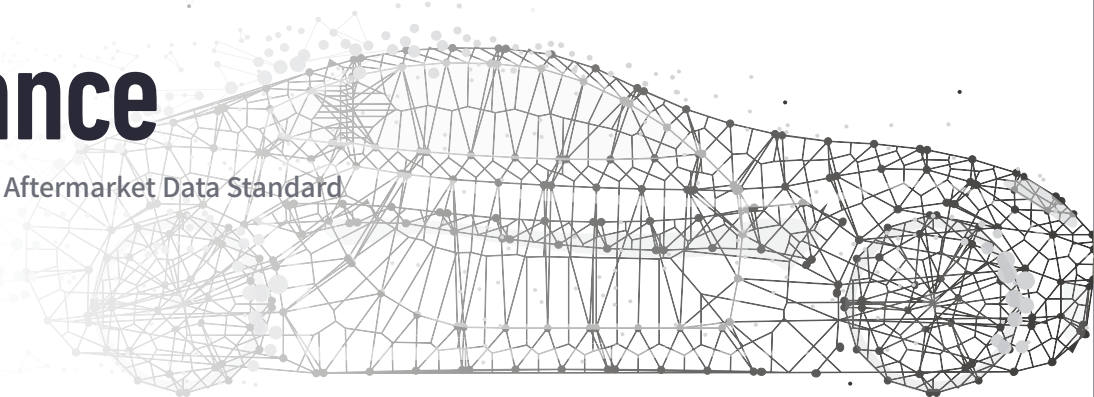

TecAlliance

International Automotive Aftermarket Data Standard



TecAlliance, founded in 1994, was formerly known as TecDoc in Germany. Until now, TecAlliance Asia Pacific has set up branches in many major countries and regions, including China's mainland, Taiwan, Korea, Malaysia, Thailand, Vietnam etc. TecAlliance is proactively exploring and expanding its Asia Pacific market, providing data, services and comprehensive solutions to many local markets.

TecAlliance has been committed to providing standardized data and data standardization services to the independent automotive aftermarket, with our TecDoc Standard becoming the universally acknowledged data standard in the industry, representing an authoritative data quality certification.

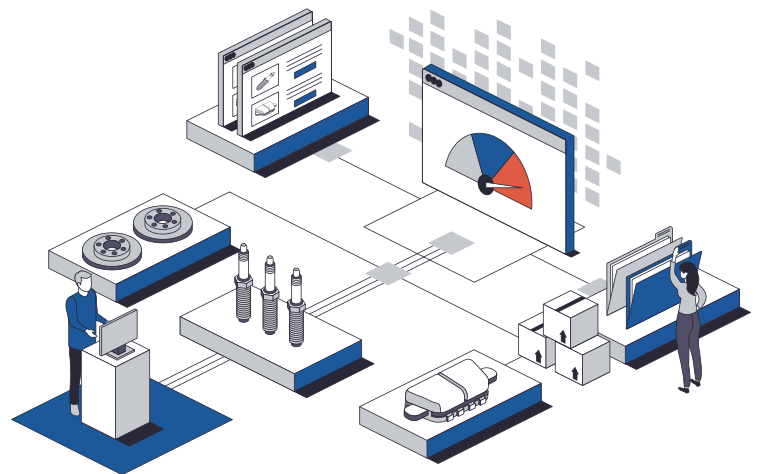

28 years' experience

1400+ brands

140 countries

8.8 million parts

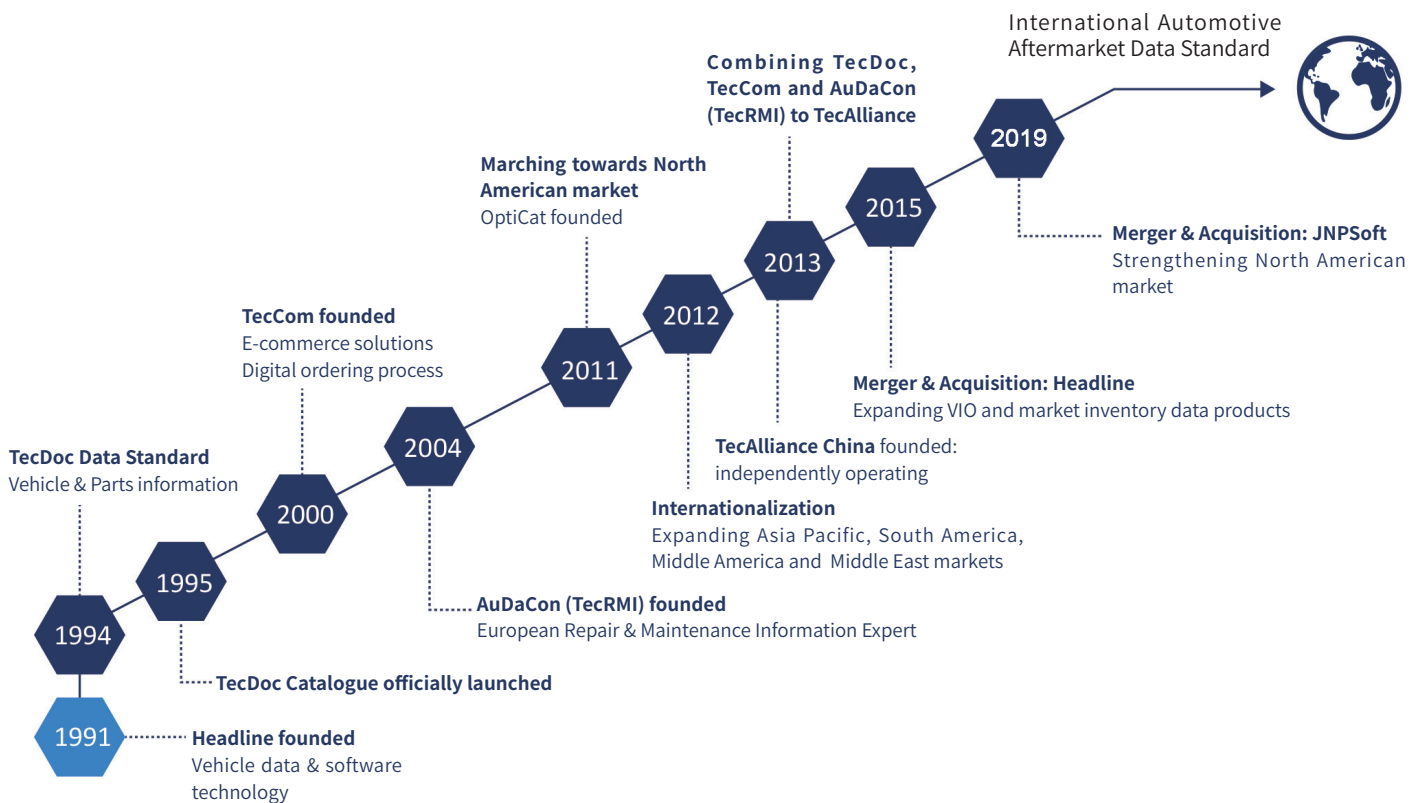

Data Supplier (DS) Service

- Speed up market expansion (both domestic and overseas), promote products to targeted markets & customers and help achieve sales goals at the earliest time possible for parts manufacturers and traders
- Service coverage areas:
 - Europe: all countries
 - America: North / South / Central America
 - Asia: East / Southeast / South / Central / West Asia
 - Oceania
 - Africa

TecDoc Global Catalogue 3.0

Global Vehicle & Parts Information Search Catalogue

- ✓ Covering 900+ parts brands, 160,000 vehicles and 8.8 million parts on a global scale
- ✓ Multiple search methods: Parts number, OE number, VIN code, Engine number, vehicle type
- ✓ Abundant functions: product comparison & screening
- ✓ Web Catalogue (PC end) & Catalogue APP (Mobile end)

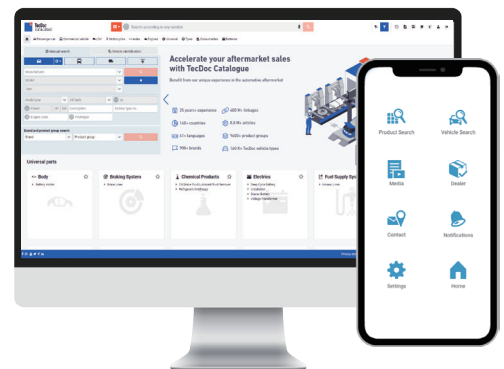

Customized E-Catalogue

Web Catalogue, WeChat Catalogue & Catalogue APP

- ✓ Convenient search UI (User Interface)
- ✓ Multiple search methods: vehicle type, VIN code, Parts number
- ✓ PC & Mobile end

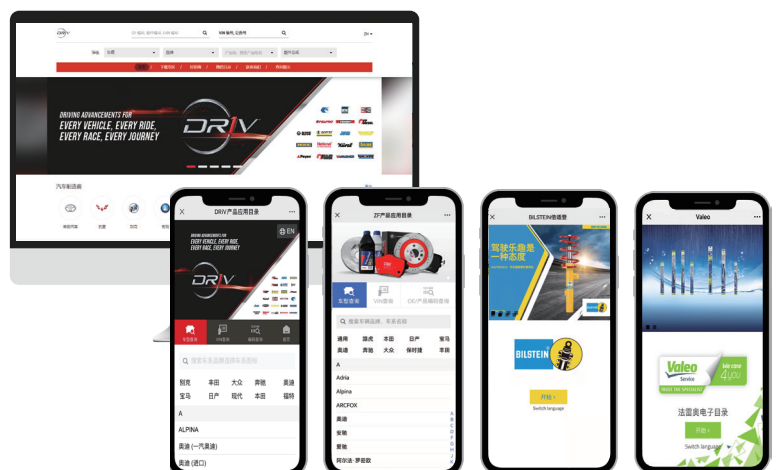

Vehicle Data

Vehicle data comes from information released by multiple official channels

Vehicle Information

- TecAlliance Standard Vehicle (K Type)
- Updated every month

VIO (Vehicles in Operation)

- VIO data for 77 countries across the globe
- Passenger Cars, Light Commercial Vehicles, Heavy Commercial Trucks & Buses
- More than 60 vehicle attributes



OE Data Research

OE data comes from EPC

 **For customer's targeted market, TecAlliance can provide standard OE research service, which includes vehicle linkages, OE number, substitution relations etc.**

Service coverage countries & regions:

East Asia: China's mainland / Hong Kong / Taiwan / Korea / Japan

Southeast Asia: Malaysia / Thailand / Singapore / Indonesia / Vietnam / Philippines

Europe: all countries

South America: Brazil / Argentina

North America: USA / Canada / Mexico



Webservices (API)

Direct access to vehicle & parts data

✓ VIN – Vehicle

- Identify a vehicle by VIN number and find corresponding vehicle attributes, including brand, car series, body structure, displacement, drive mode, horsepower, cylinder, number of valves per cylinder, engine type, fuel type, year of production & shutdown etc.
- Available for China, South Korea and Southeast Asia (Indonesia / Malaysia / Singapore / Thailand / Vietnam / Philippines)
- In China, vehicle database contains standard KType and Sales Type vehicles.

✓ Katashiki – Vehicle

- Identify a vehicle by Katashiki number and find more than 30 vehicle attributes, including brand, car series, body structure, displacement, drive mode, horsepower, cylinder, number of valves per cylinder, engine type, fuel type, year of production & shutdown etc.

✓ Vehicle – Parts

- Linked parts can be identified by vehicles. Parts information includes basic attributes, OE information, photos and vehicle linkages.

✓ Any number – Parts

- Numbers include OE number, Parts number, EAN code, Trade number, Competitor number, etc.



Data Customization Services

Data Mapping

- Standardize data based on customer's needs and data application scenarios to support data maintenance, management and wide usage on different platforms.

Customized Research & Data Analysis

- Search and process data or relevant information based on customer's interested products before sending out in the designated format.

Database Building

- Based on TecDoc experience and customer's requirements, design & build a database

Do it for Me (DIFM)

- For customers without a professional data team or requiring less time spent on data processing
- Process daily data for customers
- Comprehensive usage of multiple data sources to help analyze & improve product portfolio

Repair & Maintenance Information

Repair Information

Benz, BMW, Audi (both imported and domestically-made)

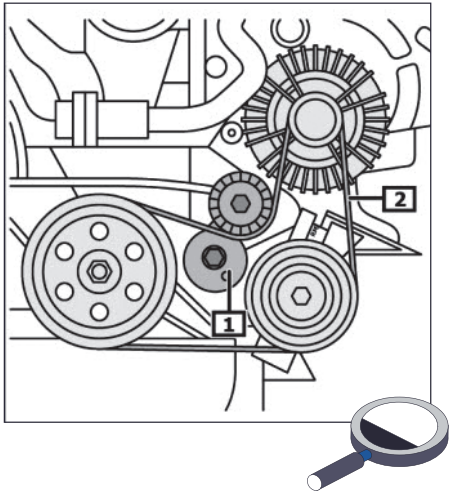

Maintenance Information

All brands in China

- Imported Brands
- Joint Venture Brands
- Independent Brands

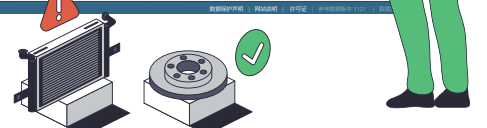
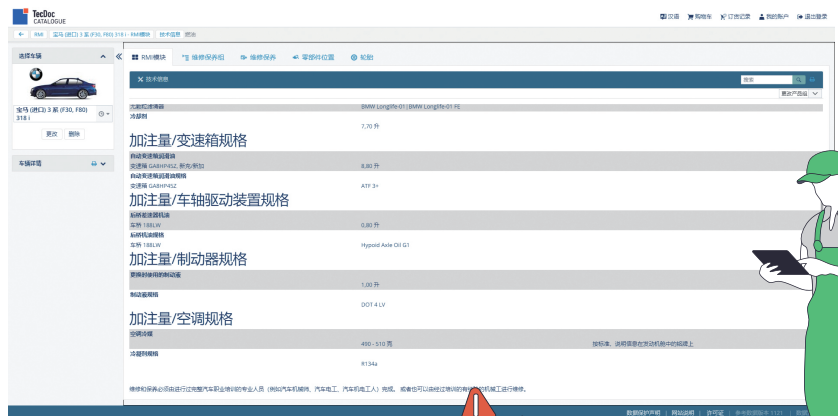

Other Services

Sample Purchase

PC sample purchase service, including OE samples and IAM brand samples.

FEMFM Brake Pad and Brake Disc Fitting Instructions

Product types:

1. For Europe:

- Supports 25 European languages
- For the installation and removal of brake discs / brake drums / disc brake pads for PV and LCV, and that of disc brake pads for HCV

2. For Asia Pacific:

- Supports 9 Asia Pacific languages
- For the installation and removal of disc brake pads for PV and LCV

3. For China:

- Supports one language: Chinese
- For the installation and removal of disc brake pads for PV and LCV

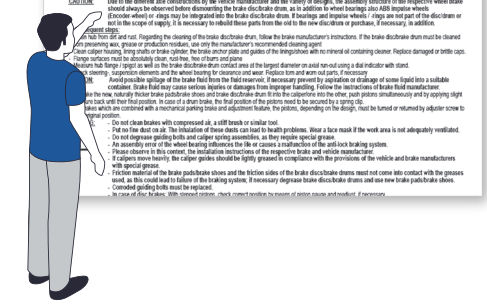

Digital Warranty & Returns Solution



Highlights

Different application scenarios

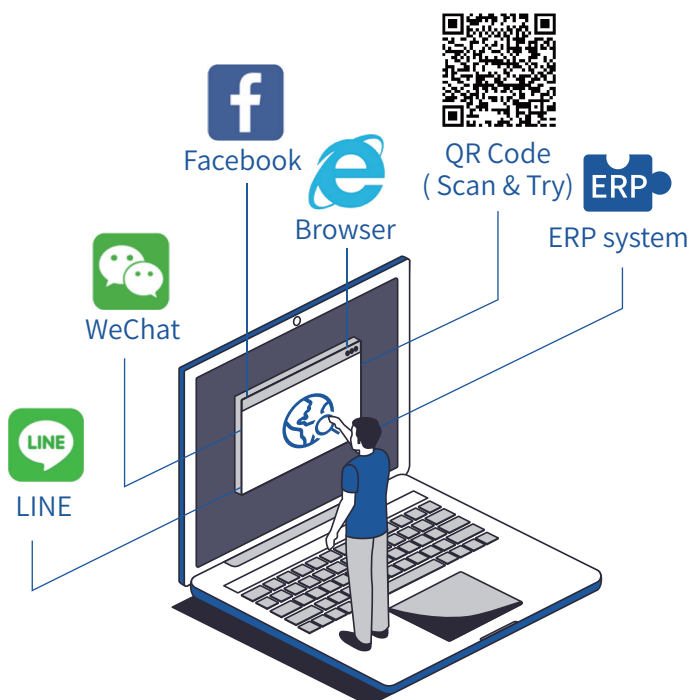

Simple Procedures

- Standard forms can effectively guide dealers to submit claims
- Manufacturers can forward claims to upper stream suppliers with one click



Cost Saving

- Manufacturers to decide whether returning goods is needed
- Save unnecessary delivery cost for goods returning



Personalized Settings

- Define your own application form
- Streamline communication



Publicity & Transparency

- Notify dealers on every update

Order Manager



Highlights

- Channel Advantages**
 Help expand sales markets in Europe
 Channel 40,000+ dealers on the OM platform
- Multiple Language Settings**
 20+ languages
 Globally available
- Catalogue to Shopping**
 TecDoc Catalogue
 TecCom ordering system
- In Pursuit of Further Development**
 Based on 20+ years' experience
 Ever improving & evolving
- Efficient Cross Communication**
 Send orders to multiple product suppliers
 Connect global dealers

Partial List of Partners



TecAlliance Malaysia
 12 Persiaran 118C, Desa Tun Razak Industrial Park,
 Cheras 56000 Kuala Lumpur
 Tel: +60 3-9226 5769
 Email Add: sales_sea@tecalliance.net